

ALKALINE-MANGANESE DIOXIDE BATTERY

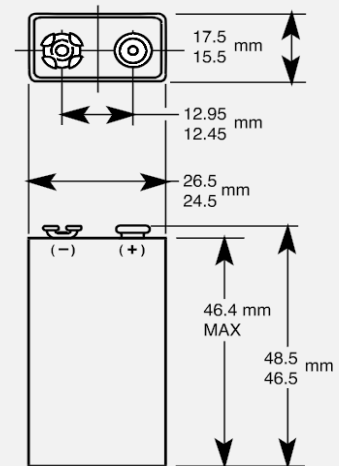

size: 9V (6LR61) PC1604



Dimensions shown are IEC standards

KEY FEATURES

- Reliable Performance
- Excellent resistance to corrosion
- Designed to meet all major quality, safety and environmental standards:
 - Safety: IEC 60086-5
 - ANSI C 18.1M, Part-2
 - EU Battery Directive
 - Quality: ISO 14001 and 9001, Duracell World Class Continuous Improvement Program

TYPICAL APPLICATIONS

- Carbon Monoxide Detectors
- Smoke Detectors
- Multimeters
- Medical Devices
- Microphones

ELECTRICAL CHARACTERISTICS

- | | |
|---|----------|
| ▪ Nominal capacity (2 mA Cont., 5V cut-off) | 673 mAh |
| ▪ Typical Voltage (at + 20 °C) | 9 V |
| ▪ AC Impedance @ 1kHz | 1,700 mΩ |

PHYSICAL CHARACTERISTICS

- | | |
|------------------|---|
| ▪ Typical weight | 45.0 g (1.6 oz) |
| ▪ Typical volume | 22.8 cm ³ (1.4 in ³) |
| ▪ Terminals | Miniature snap |

OPERATING & STORAGE CONDITIONS

- | | |
|--|----------------------------------|
| ▪ Operating temperature range | -20°C to 54°C
(-4°F to 130°F) |
| ▪ Recommended Storage (storage area should be clean, cool, dry and ventilated) | 5°C to 30°C
(41°F to 86°F) |



Zehnder Batterien AG
Gewerbstrasse 3 | 5037 Muhen | Schweiz
+41 62 737 66 10 | zehnder@zehnder-batterien.ch
www.zehnder-batterien.ch

Delivered capacity is dependent on the applied load, operating temperature and cut-off voltage. Please refer to the charts and discharge data shown for examples of the energy/service life that the battery will provide for various load conditions.

This data is subject to change. Performance information is typical. Contact Duracell for the latest information.

TYPICAL PERFORMANCE

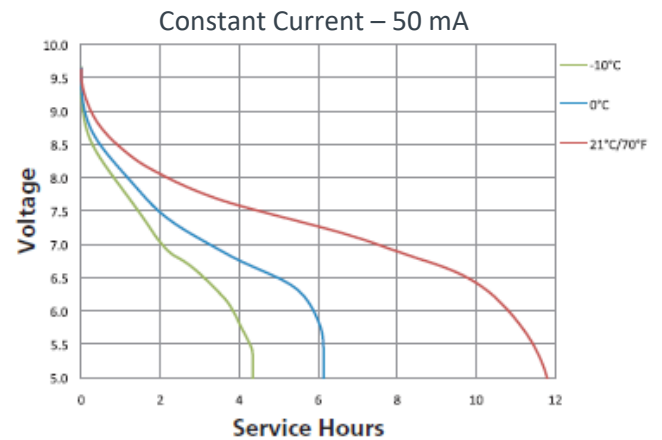
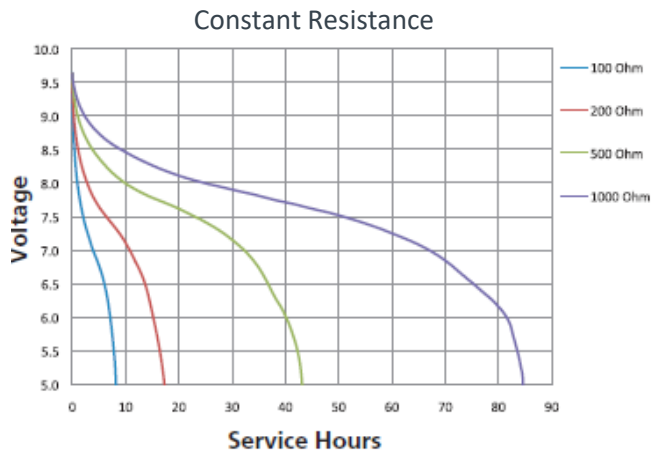
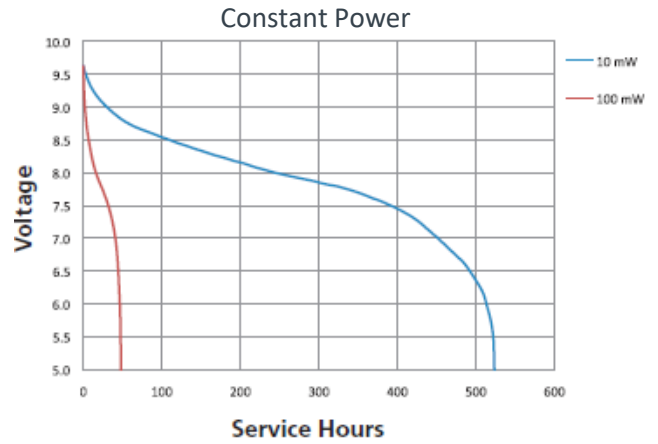
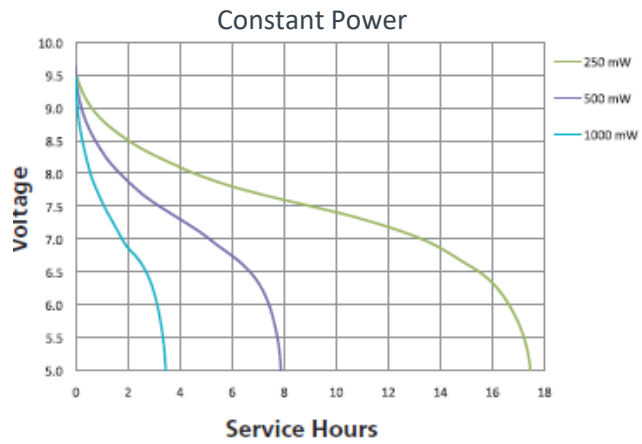
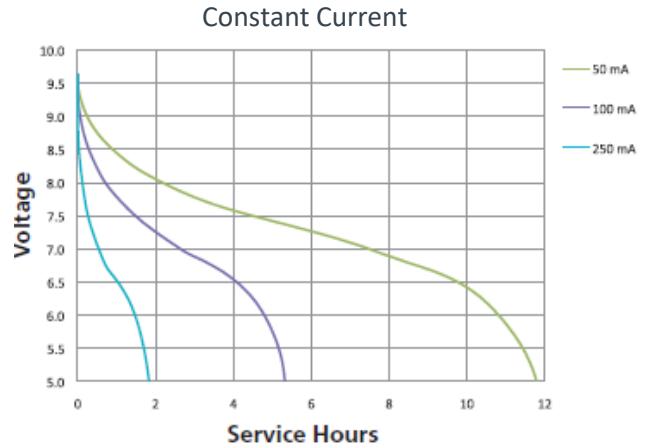
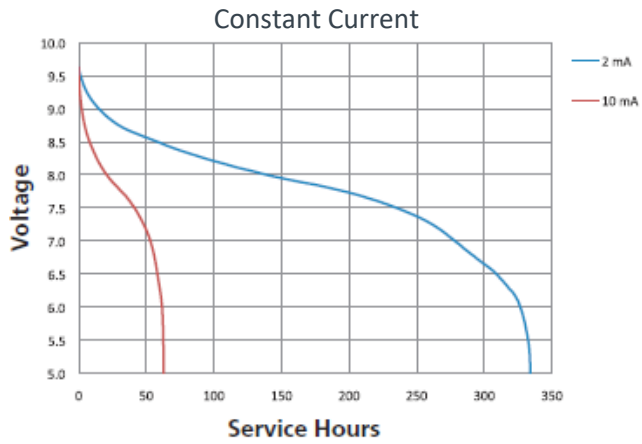

Zehnder Batterien AG
Gewerbstrasse 3 | 5037 Muhen | Schweiz
+41 62 737 66 10 | zehnder@zehnder-batterien.ch
www.zehnder-batterien.ch

Delivered capacity is dependent on the applied load, operating temperature and cut-off voltage. Please refer to the charts and discharge data shown for examples of the energy/service life that the battery will provide for various load conditions.

This data is subject to change. Performance information is typical. Contact Duracell for the latest information.